

NuZar R24

Water Purification System

R

Tap water to RO water (24 L/h)

NuZar R24 water system set is a compact water purification system, producing reverse osmosis water directly from tap water. The system can produce 24 liters of RO water per hour.

The NuZar systems introduce a unique series to the RephiLe water purification portfolio. They are specifically designed for laboratories that demand a balance between cost of ownership and exceeding their purified water requirements.



Compact and powerful.

Key Features

Reliable, Stable, Traceable and Predictable

Simple installation and maintenance

- ◊ RFID tracking of consumables (RO Pack included) for enhanced management
- ◊ Easy to remove consumable access cover.
- ◊ Automatic RO membrane cleaning cycles (Cl₂ and pH cleaning)

Low running cost

- ◊ Self-maintenance functions for maximum RO membrane effectiveness and lifetime
- ◊ RFID record of cartridge history for predictable consumable replacements
- ◊ Highly-efficient cartridges

Reliable water quality & stable system performance

- ◊ Stable RO permeability over a wide range of temperatures
- ◊ Diversion to drain if quality of RO permeate falls below a pre-set set-point
 - ◊ Mercury-free germicidal UVC LED lamp preinstalled in tank sanitation module

Data traceability

- ◊ Automatic data backup for up to 2 years
- ◊ Easy data transfer through multiple interfaces, such as LAN, USB, etc.

Compact and small footprint

- ◊ An in-built single pretreatment P Pack
- ◊ Placement flexibility - on the bench or on a wall
- ◊ Two dispenser heights
- ◊ All-in-one design. Space-Saver

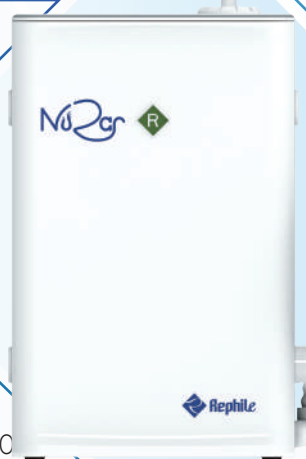

Components & Parts

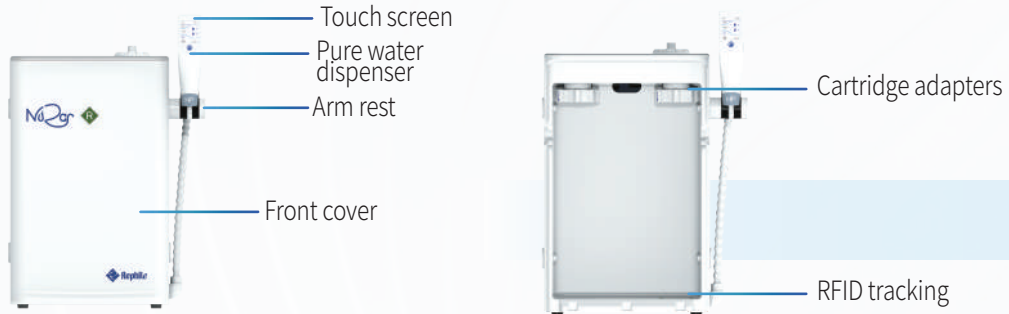

Cartridge

- ◇ Optimized flow design to improve water quality stability & efficiency of polishing resins
- ◇ High pressure rated housings, proprietary sealing, and double O-ring design ensures operational confidence
- ◇ Cartridge color, label, and RFID recognition prevent incorrect installation



Ergonomic dispenser with 2.4" color touch screen

- ◇ One dispenser for one system
- ◇ Intuitive display -water quality with temperature compensation, volumetric dispensing & flow rate
- ◇ System alerts are displayed on the touch screen
- ◇ Effortless adjustment -dispensing rate (up to 2 L/min), manual and volumetric dispensing
- ◇ 0.2 µm final filter (optional)

Two dispenser heights for the ultimate in flexibility



Storage Tank

- ◇ A 10 L integrated HDPE tank equipped with sanitization module, mercury-free germicidal UVC LED lamp (peak emission wavelength at 265 nm) preinstalled.

Extendable to 30/60/100/350 L (with mercury-free tank sanitization module) if needed



The system is manufactured in our production facility registered by ISO 9001:2015 & ISO 14001:2015. It is CE/RoHS certified.

Main Application



- Washing machine for glassware cleaning
- Feed water for laboratory animals
- Feed water for humidifiers, autoclaves, etc.
- Water supply for ultrapure water systems
- Hydroponics

Flow Schematics

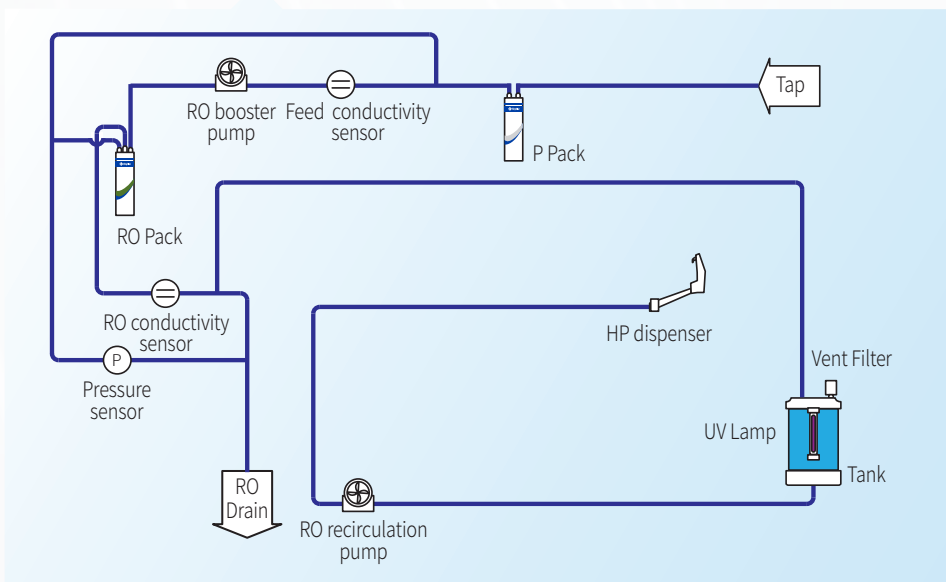

Rephile NuZar systems incorporate advanced technologies and optimized flow paths to ensure exceptional water quality for customers' applications.

Comprehensive process control management with continuous water purity monitoring after every purification step. This allows consistent and reliable operation which ensures the product meets the NuZar specifications.

Installation Information

Plug-N-Play with only 3 steps

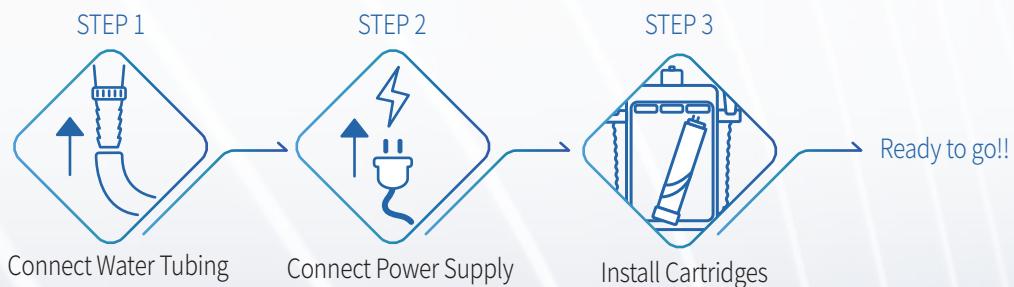

Ordering Info

Description	Cat. No.
NuZar water system set, R24	RN0R020T1K

Specifications

General Specifications		NuZar R
Operating voltage		24 VDC
Input voltage		100 - 240 VAC
Main system power		< 190 W
Feed Water Requirements		
Feed water		Tap water
conductivity		< 2000 $\mu\text{S/cm}$
TDS		< 1000 ppm
Operating temperature		5 - 35 $^{\circ}\text{C}$
Feed water pressure		1 - 6 bar (15 - 90 psi)
Product Water Type		RO
Dimensions W x D x H	w/ integrated tank	414 x 422 x 624 mm (16.3 x 16.6 x 24.5 in)
Weight (Approximate)	net	19 kg
	gross	28 kg

Product water Specifications

● RO water

Production rate (@25 $^{\circ}\text{C}$)	24 L/hr
Conductivity (@25 $^{\circ}\text{C}$)	Typically < 20 $\mu\text{S/cm}$
RO rejection	97 to 98% ionic rejection (new RO cartridge) > 99% organic rejection > 99% particulates & bacteria rejection

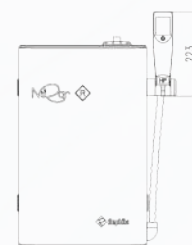

Front view

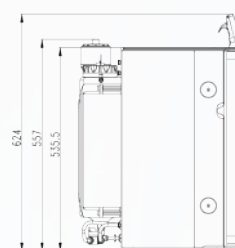

Side view

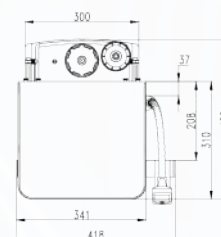

Top view

Rephile Bioscience, Ltd.

Toll Free: +1-855-Rephile (+1-855-737-4453)

E-mail: info@rephile.com

All rights reserved © 2023 Rephile Bioscience, Ltd.

Rephile and NuZar are registered trademarks of

Rephile Bioscience, Ltd.

All other trademarks mentioned are the property of their respective owners.

TM and [®] may be omitted in this brochure.



Literature: RFPR1552303